

# AUTOMATIC OPERATOR ACTUATORS & ACCESSORIES

## 8310 Series 4-1/2" Surface and Flush mounts

The actuators and accessories on the following pages are to be used with LCN automatic operators. When using actuators supplied by others, such as card readers, consult the factory.

The desired function, traffic patterns and physical design of the opening will determine the type of actuators used. Generally, for two-way traffic, an actuator is required on both the interior and exterior side of the door. Each actuator is packaged with a decal to be applied to the controlled door. Scanners operate on 12V or 24V AC/DC and may be powered by the LCN electrohydraulic/electromechanical operators. The 7900 series control box requires separate power supply for scanners. Actuators provide normally open (N.O.) dry contacts.

### WALL MOUNTED ACTUATOR, 8310-856

Hardwired low voltage actuator with round, stainless steel touch plate in 4-1/2" (114mm) diameter. Engraved blue filled handicap symbol conforms to most accessibility codes. Designed to mount in a flush or surface mount box (sold separately) in/on a vertical surface near the controlled door. Optional mounting in single gang electrical box (by others). Heavy industrial grade components provide vandal resistant mounting and weather resistant switch standard.

### WALL MOUNTED ACTUATOR, 8310-856T

Same as the 8310-856, with the added engraving of "Push to Open".

### FLUSH MOUNT BOX, 8310-868F

Rugged Plastic Box, 4-1/2" Round. Optional accessory - Can be used w/any 4-1/2" round actuator.

### SURFACE MOUNT BOX, 8310-868S

Rugged Plastic Box, 4-1/2" Round. Optional accessory - Can be used w/any 4-1/2" round actuator.

### WEATHER/TRIM RING, 8310-800

Weather/Trim Ring, 4-1/2" Round. Optional accessory - Must be used w/any 4-1/2" round plastic mounting box.

### TRANSMITTER, 8310-844

Transmitter, Wireless, 1 Channel, 9v battery included. Use to convert standard wall mount actuator to wireless. Requires 8310-865 Receiver.

### RECEIVER, 8310-865

Receiver, Wireless, 1 Channel, w/Sequencing Feature. Used in conjunction w/ Wireless Actuators & Transmitter(s).

### ESCUTCHEON, 8310-874

Tapered stainless steel escutcheon covers the gap between the wall and the back of the wall plate actuators when mounted in electrical boxes (by others) to minimize cart damage or vandalism. Optional accessory - Can be used w/any 4-1/2" round actuator.

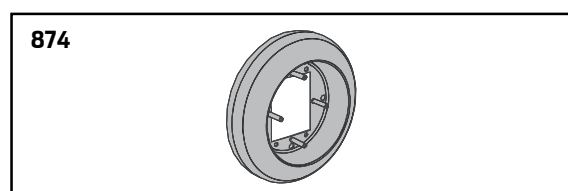
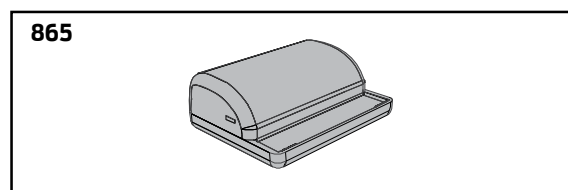
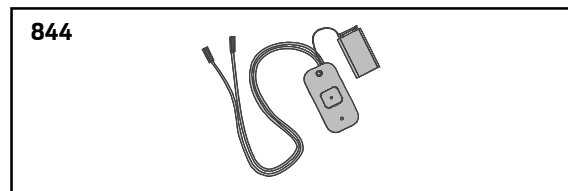
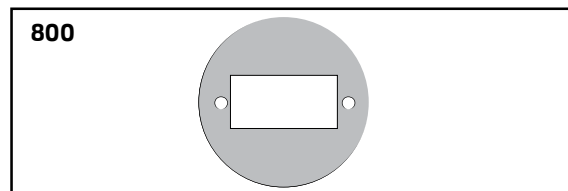
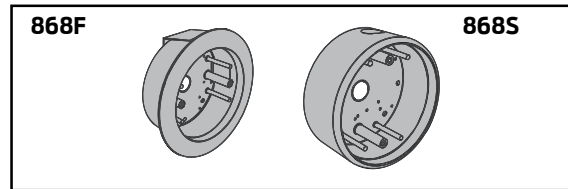
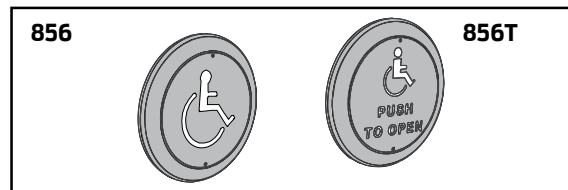

# AUTOMATIC OPERATOR ACTUATORS & ACCESSORIES

## 8310 Series 4-1/2" Surface and Flush mounts

### FLUSH MOUNT KIT, 8310-3856WF

Actuator, 4-1/2" Round, Logo, Wireless  
Includes 8310-856 Actuator, 8310-844 Transmitter, 8310-868F Flush Box, 8310-800 Weather/Trim Ring.  
Requires 8310-865 Receiver (not part of kit).

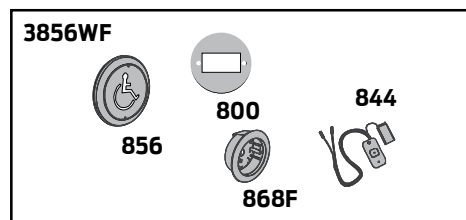

### SURFACE MOUNT KIT, 8310-3856WS

Actuator, 4-1/2" Round, Logo, Wireless,  
Includes 8310-856 Actuator, 8310-844 Transmitter, 8310-868S Surface Box, 8310-800 Weather/Trim Ring.  
Requires 8310-865 Receiver (not part of kit).

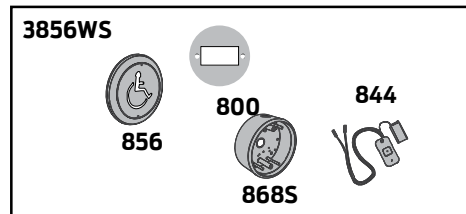

### FLUSH MOUNT KIT, 8310-3856TWF

Actuator, 4-1/2" Round, Logo, Text, Wireless,  
Includes 8310-856T Actuator, 8310-844 Transmitter, 8310-868F Flush Box, 8310-800 Weather/Trim Ring.  
Requires 8310-865 Receiver (not part of kit).

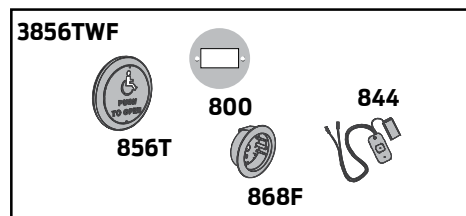

### SURFACE MOUNT KIT, 8310-3856TWS

Actuator, 4-1/2" Round, Logo, Text, Wireless,  
Includes 8310-856T Actuator, 8310-844 Transmitter, 8310-868S Surface Box, 8310-800 Weather/Trim Ring.  
Requires 8310-865 Receiver (not part of kit).

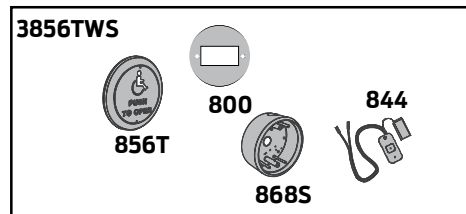

### SURFACE MOUNT KIT, 8310-3860T

Actuator Package, 4-1/2" Round,  
Includes 8310-856T (2) Wall Mount Actuator, 8310-868S Surface Mount Box.

*NOTE: Weather/Trim Rings are sold separately.*

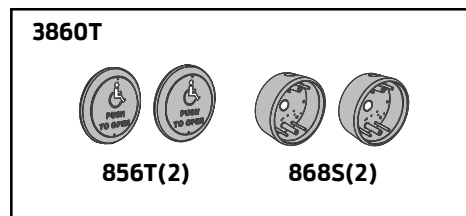

### SURFACE MOUNT KIT, 8310-3860TW

Actuator Package, 4-1/2" Round, Wireless,  
Includes 8310-856T (2) Wall Mount Actuator, 8310-868S (2) Surface Mount Box, 8310-800 (2) Weather/Trim Ring, 8310-844 (2) Transmitter, 8310-865 Receiver.

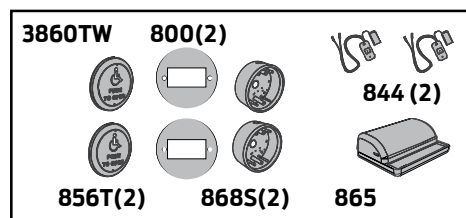

# AUTOMATIC OPERATOR ACTUATORS & ACCESSORIES

## 8310 Series 6" Surface and Flush mounts

### WALL MOUNTED ACTUATOR, 8310-852

Hardwired low voltage actuator with round, stainless steel touch plate in 6" (152mm) diameter. Engraved blue filled handicap symbol conforms to most accessibility codes. Designed to mount in a flush or surface mount box (sold separately) in/on a vertical surface near the controlled door. Optional mounting in single gang electrical box (by others) or double gang box (4" x 4" by others). Heavy industrial grade components provide vandal resistant mounting and weather resistant switch standard.

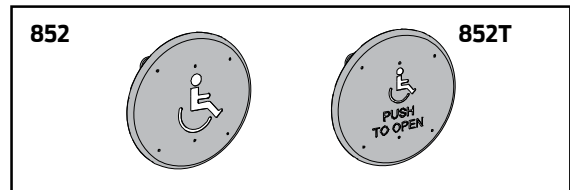

### WALL MOUNTED ACTUATOR, 8310-852T

Same as the 8310-852, with the added engraving of "Push to Open".

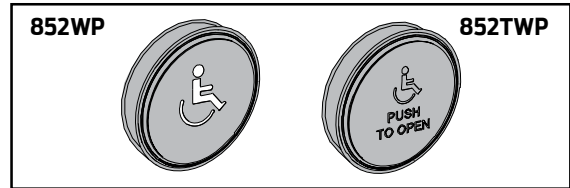

### WALL MOUNTED ACTUATOR, 8310-852WP

Wireless, low profile, low voltage actuator with round, stainless steel touch plate in 6" (152mm) diameter. Engraved blue filled handicap symbol conforms to most accessibility codes. Surface mount box includes integral transmitter w/ battery and actuator switch. Heavy industrial grade components provide vandal resistant mounting and weather resistant switch standard. Requires 8310-865 Receiver.

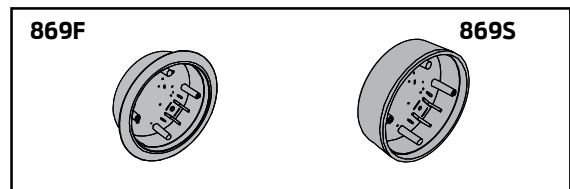

### WALL MOUNTED ACTUATOR, 8310-852TWP

Same as the 8310-852WP, with the added engraving of "Push to Open".

### FLUSH MOUNT BOX, 8310-869F

Rugged Plastic Box, 6" Round. Optional accessory - Can be used w/ any 6" round actuator.

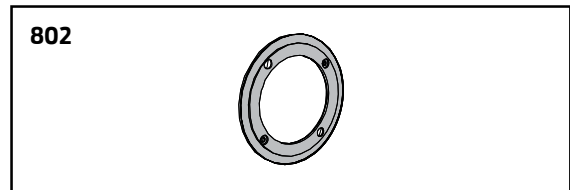

### SURFACE MOUNT BOX, 8310-869S

Rugged Plastic Box, 6" Round. Optional accessory - Can be used w/ any 6" round actuator.

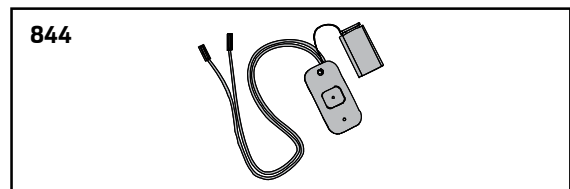

### WEATHER/TRIM RING, 8310-802

Plastic Weather/Trim Ring, 6" Round. Optional accessory - Can be used w/ any 6" round plastic mounting box.

### TRANSMITTER, 8310-844

Transmitter, Wireless, 1 Channel, 9v battery included. Use to convert standard wall mount actuator to wireless. Requires 8310-865 Receiver.

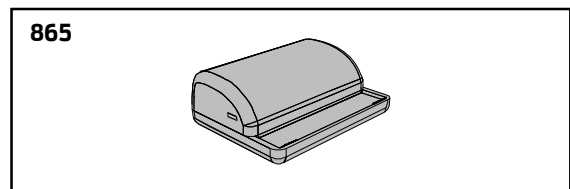

### RECEIVER, 8310-865

Receiver, Wireless, 1 Channel, w/ Sequencing Feature Used in conjunction w/ Wireless Actuators & Transmitter(s).

### ESCUTCHEON, 8310-876

Tapered stainless steel escutcheon covers the gap between the wall and the back of the wall plate actuators when mounted in electrical boxes (by others) to minimize cart damage or vandalism. Optional accessory - Can be used w/ any 6" round actuator.

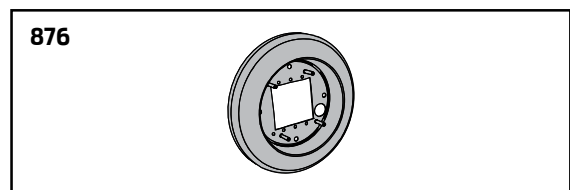

# AUTOMATIC OPERATOR ACTUATORS & ACCESSORIES

## 8310 Series 6" Surface and Flush mounts

### FLUSH MOUNT KIT, 8310-3852WF

6" Round, Logo, Wireless,

Includes 8310-852 Actuator, 8310-844 Transmitter, 8310-869F Flush Box, 8310-802 Weather/Trim Ring.  
Requires 8310-865 Receiver (not part of kit).

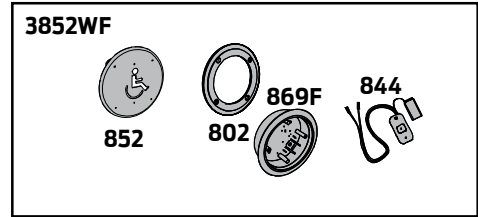

### SURFACE MOUNT KIT, 8310-3852WS

6" Round, Logo, Wireless,

Includes 8310-852 Actuator, 8310-844 Transmitter, 8310-869S Surface Box, 8310-802 Weather/Trim Ring.  
Requires 8310-865 Receiver (not part of kit).

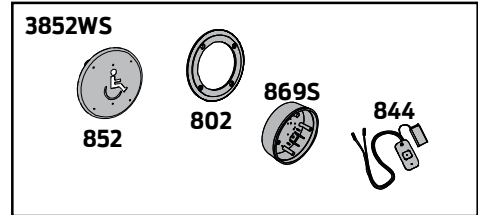

### FLUSH MOUNT KIT, 8310-3852TWF

6" Round, Logo, Text, Wireless,

Includes 8310-852T Actuator, 8310-844 Transmitter, 8310-869F Flush Box, 8310-802 Weather/Trim Ring.  
Requires 8310-865 Receiver (not part of kit).

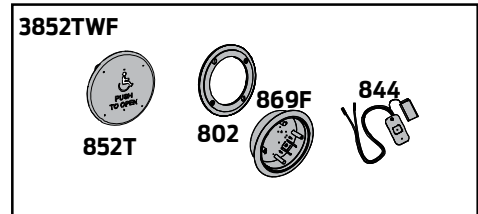

### SURFACE MOUNT KIT, 8310-3852TWS

6" Round, Logo, Text, Wireless,

Includes 8310-852T Actuator, 8310-844 Transmitter, 8310-869S Surface Box, 8310-802 Weather/Trim Ring.  
Requires 8310-865 Receiver (not part of kit).

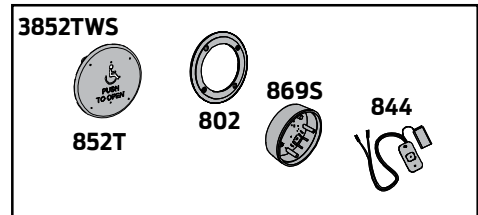

# AUTOMATIC OPERATOR ACTUATORS & ACCESSORIES

## 8310 Series 1-1/2" x 4-3/4" Surface and Flush mounts

**NOTE:** LCN recommends for all jamb mount actuators be used on an interior installation only.

### JAMB MOUNTED ACTUATOR, 8310-818

Hardwired low voltage actuator with rectangular stainless steel touch plate. 1-1/2" (38mm) wide by 4-3/4" (121mm). Engraved blue filled handicap symbol conforms to most accessibility codes. Designed to mount in a frame cutout (template provided) projecting approximately 1/2" (12mm) from the frame. Optional mounting in surface or flush mount box (sold separately). Heavy industrial grade components provide vandal resistant mounting and weather resistant switch standard.

### JAMB MOUNTED ACTUATOR, 8310-818T

Same as the 8310-818, with the added engraving of "Push to Open".

### FLUSH MOUNT BOX, 8310-819F

Rugged Plastic Jamb Box, 1-1/2" x 4-3/4" Rectangle, Optional accessory - Can be used w/ any 1-1/2" x 4-3/4" jamb mount actuator.

### SURFACE MOUNT BOX, 8310-819S

Rugged Plastic Jamb Box, 1-1/2" x 4-3/4", Rectangle. Optional accessory - Can be used w/ any 1-1/2" x 4-3/4" jamb mount plastic mounting box.

### TRANSMITTER, 8310-844J

Transmitter, Wireless, 1 Channel, Jamb Mount, 3v battery included. Used to convert standard jamb mount actuator to wireless when used w/ 819F or 819S boxes. Requires 8310-865 Receiver (interior use only).

### RECEIVER, 8310-865

Receiver, Wireless, 1 Channel, w/ Sequencing Feature. Used in conjunction w/ Wireless Actuators & Transmitter(s).

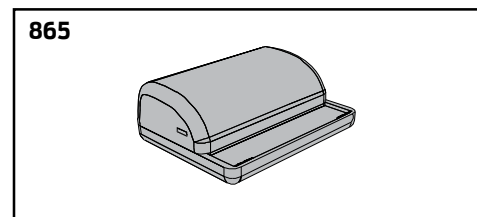
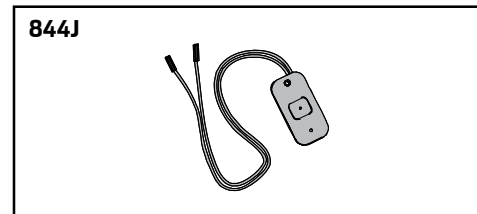
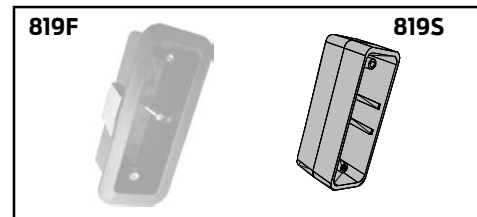
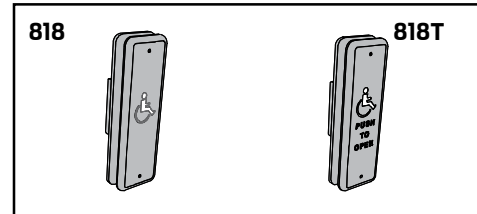

# AUTOMATIC OPERATOR ACTUATORS & ACCESSORIES

## 8310 Series 1-1/2" x 4-3/4" Surface and Flush mounts

**NOTE:** LCN recommends for all jamb mount actuators be used on an interior installation only.

### FLUSH MOUNT KIT, 8310-3818WF

Actuator, 1-1/2" x 4-3/4" Rectangle, Logo, Wireless Includes 8310-818 Actuator, 8310-844J Transmitter, 8310-819F Flush Box. Requires 8310-865 Receiver (not part of kit).

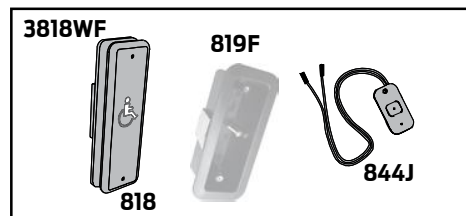

### SURFACE MOUNT KIT, 8310-3818WS

Actuator, 1-1/2" x 4-3/4" Rectangle, Logo, Wireless Includes 8310-818 Actuator, 8310-844J Transmitter, 8310-819S Surface Box. Requires 8310-865 Receiver (not part of kit).

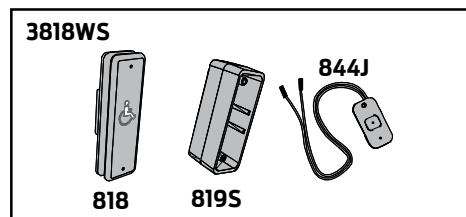

### FLUSH MOUNT KIT, 8310-3818TWF

Actuator, 1-1/2" x 4-3/4" Rectangle, Logo, Wireless Includes 8310-818T Actuator, 8310-844J Transmitter, 8310-819F Flush Box. Requires 8310-865 Receiver (not part of kit).

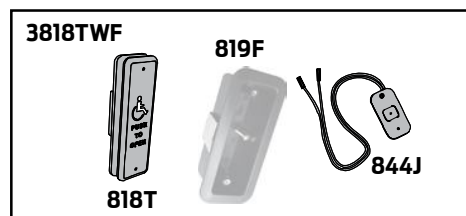

### SURFACE MOUNT KIT, 8310-3818TWS

Actuator, 1-1/2" x 4-3/4" Rectangle, Logo, Wireless Includes 8310-818T Actuator, 8310-844J Transmitter, 8310-819S Surface Box. Requires 8310-865 Receiver (not part of kit).

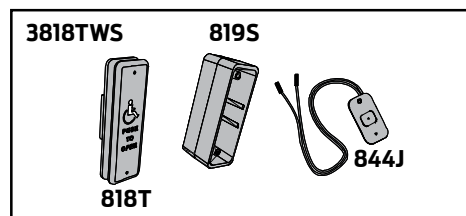

### SURFACE MOUNT KIT, 8310-3822T

Actuator Package, 1-1/2" x 4-3/4", Jamb Mount Includes 8310-818T (2) Jamb Mount Actuator, 8310-819S (2) Surface Mount Box.

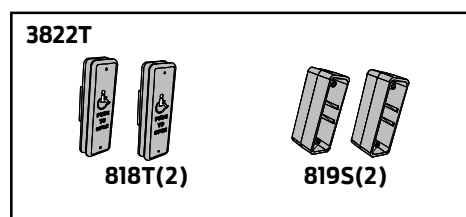

### SURFACE MOUNT KIT, 8310-3822TW

Actuator Package, 1-1/2" x 4-3/4", Wireless, Jamb Mount Includes 8310-818T (2) Jamb Mount Actuator, 8310-819S (2) Surface Mount Box, 8310-844J (2) Jamb Mount Transmitter, 8310-865 Receiver.

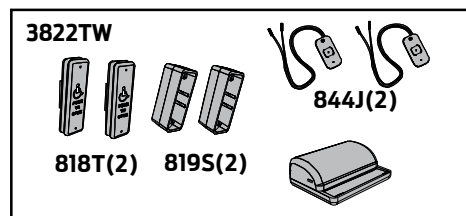

# AUTOMATIC OPERATOR ACTUATORS & ACCESSORIES

## 8310 Series 4-3/4" Square Surface and Flush mounts

### WALL MOUNTED ACTUATOR, 8310-853

Hardwired low voltage actuator with stainless steel touch plate in 4-3/4" (121mm) square. Engraved blue filled handicap symbol conforms to most accessibility codes. Designed to mount in a flush or surface mount box (sold separately) in/on a vertical surface near the controlled door. Optional mounting in single gang electrical box (by others) or double gang box (4" x 4" by others) or on an 8310-866 bollard post. Heavy industrial grade components provide vandal resistant mounting and weather resistant switch standard.

### WALL MOUNTED ACTUATOR, 8310-853T

Same as the 8310-853, with the added engraving of "Push to Open".

### SURFACE MOUNTED ACTUATOR, 8310-853WP

Wireless, low profile, low voltage actuator with round, stainless steel touch plate in 4-3/4" (121mm) square. Engraved blue filled handicap symbol conforms to most accessibility codes. Surface mount box includes integral transmitter w/ battery and actuator switch. Heavy industrial grade components provide vandal resistant mounting and weather resistant switch standard. Requires 8310-865 Receiver.

### SURFACE MOUNTED ACTUATOR, 8310-853TWP

Same as the 8310-853WP, with the added engraving of "Push to Open".

### FLUSH MOUNT BOX, 8310-867F

Rugged Plastic Box, 4-3/4" Square. Optional accessory - Can be used w/ any 4-3/4" square actuator.

### SURFACE MOUNT BOX, 8310-867S

Rugged Plastic Box, 4-3/4" Square. Optional accessory - Can be used w/ any 4-3/4" square actuator.

### WEATHER/TRIM RING, 8310-801

Plastic Weather Ring, 4-3/4" Square. Optional accessory - Can be used w/ any 4-3/4" square plastic mounting box.

### TRANSMITTER, 8310-844

Transmitter, Wireless, 1 Channel, 9v battery included. Use to convert standard wall mount actuator to wireless. Requires 8310-865 Receiver.

### RECEIVER, 8310-865

Receiver, Wireless, 1 Channel, w/ Sequencing Feature Used in conjunction w/ Wireless Actuators & Transmitter(s).

### TOUCHLESS WALL MOUNTED ACTUATOR, 8310-813

Hardwired low voltage actuator with plastic plate in 4-3/4" (121mm) square. Optional mounting in single gang electrical box (by others) or double gang box (4" x 4" by others).

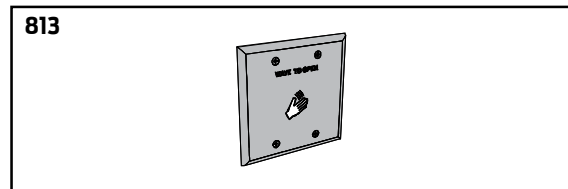
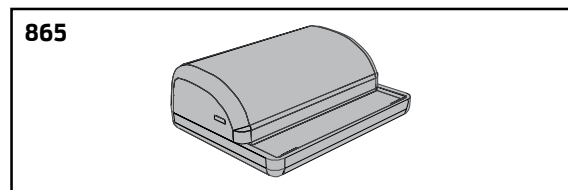
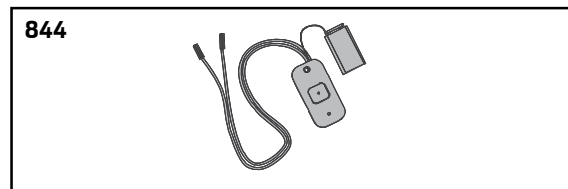
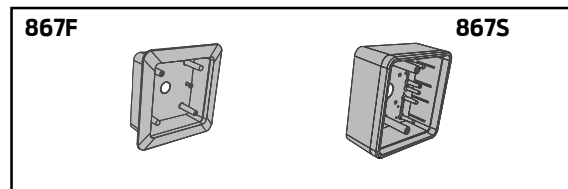
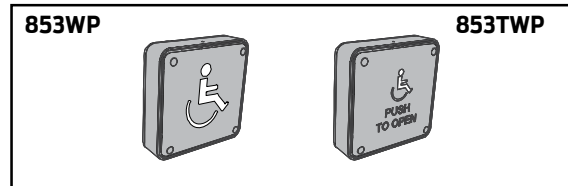
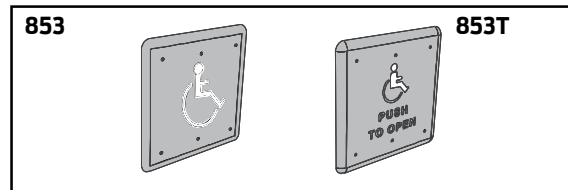

# AUTOMATIC OPERATOR ACTUATORS & ACCESSORIES

## 8310 Series 4-3/4" Square Surface and Flush mounts

### FLUSH MOUNT KIT, 8310-3853WF

Actuator, 4-3/4" Square, Logo, Wireless  
Includes 8310-853, 8310-844 Transmitter,  
8310-867F Flush Box, 8310-801 Weather/Trim Ring.  
Requires 8310-865 Receiver (not part of kit).

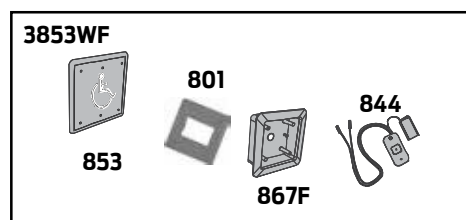

### SURFACE MOUNT KIT, 8310-3853WS

Actuator, 4-3/4" Square, Logo, Wireless  
Includes 8310-853, 8310-844 Transmitter,  
8310-867S Surface Box, 8310-801 Weather/Trim Ring.  
Requires 8310-865 Receiver (not part of kit).

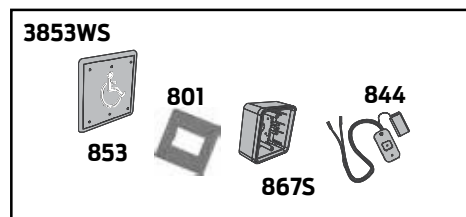

### FLUSH MOUNT KIT, 8310-3853TWF

Actuator, 4-3/4" Square, Logo, Text, Wireless,  
Includes 8310-853T, 8310-844 Transmitter,  
8310-867F Flush Box, 8310-801 Weather/Trim Ring.  
Requires 8310-865 Receiver (not part of kit).

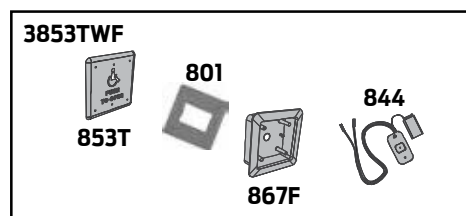

### SURFACE MOUNT KIT, 8310-3853TWS

Actuator, 4-3/4" Square, Logo, Text, Wireless  
Includes 8310-853T, 8310-844 Transmitter,  
8310-867S Surface Box, 8310-801 Weather/Trim Ring.  
Requires 8310-865 Receiver (not part of kit).

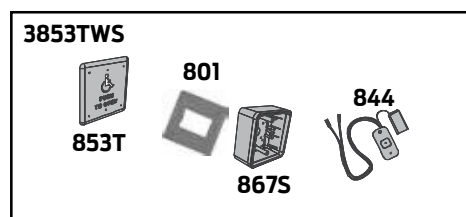

### SURFACE MOUNT KIT, 8310-3857T

Actuator Package, 4-3/4" Square  
Includes 8310-853T (2) Wall Mount Actuator, 8310-867S (2)  
Surface Mount Box.

*NOTE: Weather/Trim Ring sold separately.*

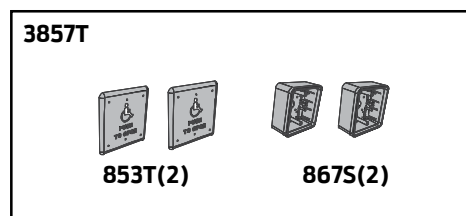

### SURFACE MOUNT KIT, 8310-3857TW

Actuator Package, 4-3/4" Square  
Includes 8310-853T (2) Wall Mount Actuator, 8310-867S  
(2) Surface Mount Box, 8310-801 (2) Weather/Trim Ring, 8310-  
844 (2) Transmitter, 8310-865 Receiver.

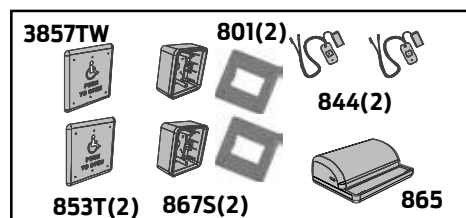



# AUTOMATIC OPERATOR ACTUATORS & ACCESSORIES

## 8310 Series 4-3/4" Dual Square Surface and Flush mounts

### DUAL WALL MOUNTED ACTUATOR, 8310-855

Hardwired low voltage actuator with dual rectangle, stainless steel touch plate in 4-3/4" (121mm) square. Engraved blue filled handicap symbol w/ text, conforms to most accessibility codes. Designed to mount in a flush or surface mount box (sold separately) in/on a vertical surface near the controlled door. Optional mounting in double gang box (4" x 4" by others) or on an 8310-866 bollard post. Heavy industrial grade components provide vandal resistant mounting and weather resistant switch standard.

### FLUSH MOUNT BOX, 8310-867F

Rugged Plastic Box, 4-3/4" Square. Optional accessory - Can be used w/ any 4-3/4" square actuator.

### SURFACE MOUNT BOX, 8310-867S

Rugged Plastic Box, 4-3/4" Square. Optional accessory - Can be used w/ any 4-3/4" square actuator.

### WEATHER/TRIM RING, 8310-801

Plastic Weather Ring, 4-3/4" Square. Optional accessory - Can be used w/ any 4-3/4" square plastic mounting box.

### TRANSMITTER, 8310-844

Transmitter, Wireless, 1 Channel, 9v battery included. Use to convert standard wall mount actuator to wireless. Requires 8310-865 Receiver.

### RECEIVER, 8310-865

Receiver, Wireless, 1 Channel, w/ Sequencing Feature Used in conjunction w/ Wireless Actuators & Transmitter(s).

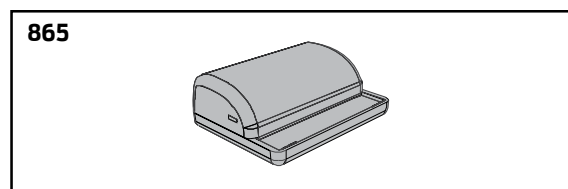
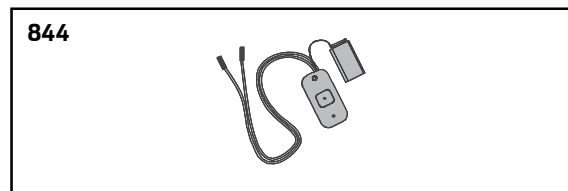
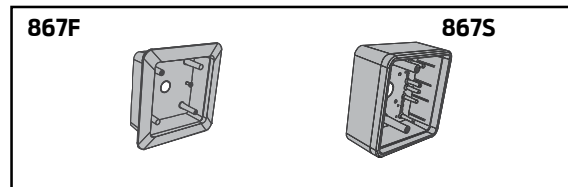

# AUTOMATIC OPERATOR ACTUATORS & ACCESSORIES

## 8310 Series 36" x 6" Full Length Actuators

### FULL LENGTH ACTUATOR (FLA), 8310-836T

Hardwired low voltage actuator with stainless steel touch plate with 36" x 6" area on surface. Blue handicap symbol conforms with most accessibility codes. Added "PUSH TO OPEN" lettering for enhanced identification. Designed to meet California building codes and increase accessibility for wheelchair bound entrants. Can easily be mounted to any flat surface or a bollard post.

### FULL LENGTH ACTUATOR (FLA), 8310-836TW

Same as the 8310-836T with a built in wireless transmitter and 3v battery. Use in conjunction with 8310-865 Receiver (not included).

### RECEIVER, 8310-865

Receiver, Wireless, 1 Channel, w/Sequencing Feature. Used in conjunction w/ Wireless Actuators & Transmitter(s).

### TRANSMITTER, 8310-844

Transmitter, Wireless, 1 Channel, 9v Battery included. Used to convert standard actuators to wireless. Requires 8310-865 Receiver. Recommended for exterior application with 8310-836T.

### FLA BOLLARD POST 8310-866FLA

A powder coated steel 4 1/2" x 4" x 6": Bollard Post, mounting base pre prepped for the 8310-836T. Includes 8310-866 CAP, 2 mounting screws & spacer for installation.

### FLA BOLLARD MOUNT KIT 8310-3836T

36" x 6" Actuator with 8310-866FLA Bollard for wired applications.

### FLA BOLLARD MOUNT 8310-3836TW

36" x 6" Actuator with 8310-866FLA Bollard and 8310-844 wireless Transmitter. Transmitter requires 8310-865 Receiver (not included).

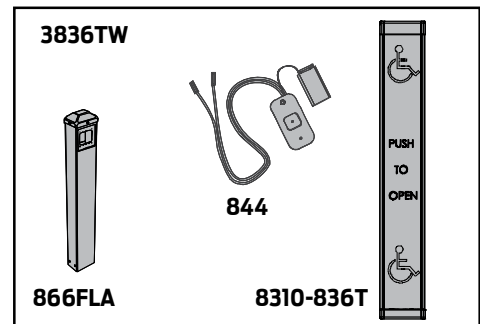
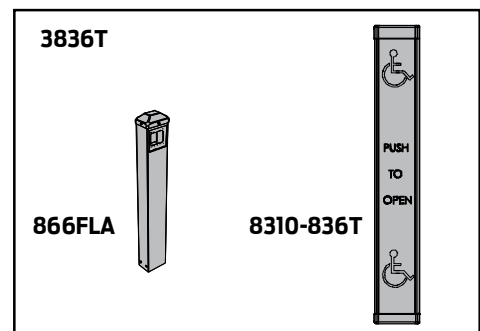
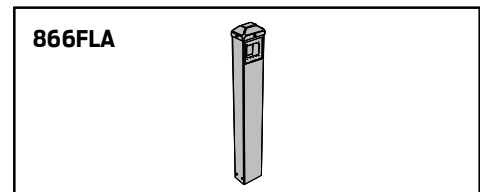
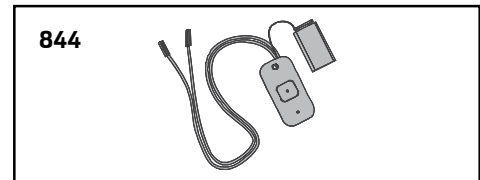
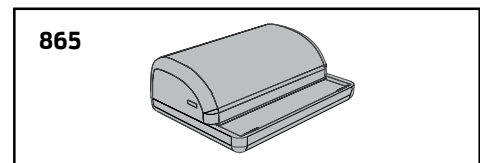
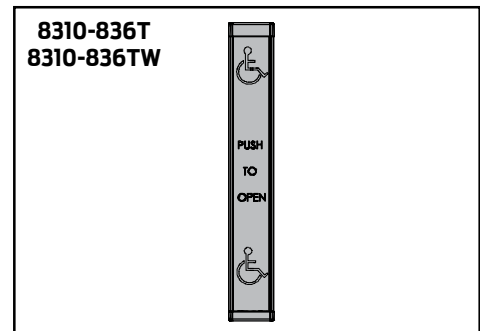

# AUTOMATIC OPERATOR ACTUATORS & ACCESSORIES

## 8310 Series 4-3/4" Dual Square Surface and Flush mounts

### FLUSH MOUNT KIT, 8310-3855WF

Actuator, 4-3/4" Square, Logo, Text, Dual Vestibule, Wireless.  
Includes 8310-855 Actuator, 8310-844 Transmitter (2),  
8310-867F Flush Box, 8310-801 Weather/Trim Ring.  
Requires 8310-865 Receiver (2) (not part of kit).

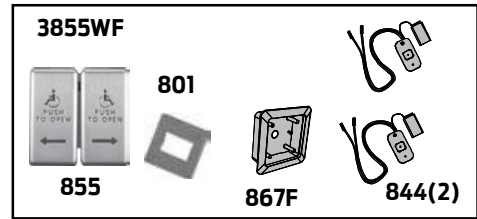

### SURFACE MOUNT KIT, 8310-3855WS

Actuator, 4-3/4" Square, Logo, Text, Dual Vestibule, Wireless.  
Includes 8310-855 Actuator, 8310-844 Transmitter (2),  
8310-867S Surface Box, 8310-801 Weather/Trim Ring.  
Requires 8310-865 Receiver (2) (not part of kit).

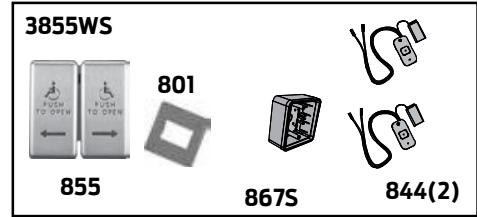

### ACTUATOR, BOLLARD MOUNT, 8310-3853WB

4-3/4" Square w/ Logo, Wireless actuator. Use w/ 8310-866  
Bollard (not included) - Includes 8310- 853 actuator, 8310-844  
Transmitter. Requires 8310-865 Receiver (not part of kit).

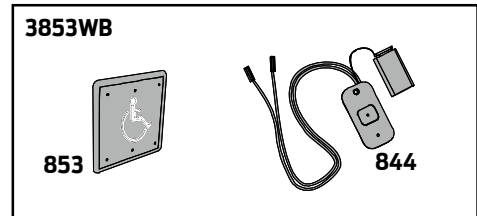

### ACTUATOR, BOLLARD MOUNT, 8310-3853TWB

4-3/4" Square w/ Logo, Text, Wireless actuator. Use w/  
8310-866 Bollard (not included) - Includes 8310- 853T actuator,  
8310-844 Transmitter. Requires 8310-865 Receiver (not part of  
kit).

